

Project Name:	Type:
Part Number:	Date:

BYPASS AND HYBRID BYPASS PLS

FEATURES

- Built-in universal driver – Bypass installation operates directly on 120–277V line voltage
- Hybrid Bypass versions can also operate directly on most magnetic ballasts*
- Bypass versions replace 7W-13W CFL lamps with 2G7 & 2GX7 bases
- Hybrid Bypass versions replace 7W-13W CFL lamps with G23 & GX23 (2-pin) bases
- Exceptional efficacy up to 113 LPW
- Suitable for damp locations
- Lamp ambient temperature: -4°F to 113°F (-20°C to 45°C)
- Fixture operating temperature: -4°F to 95°F (-20°C to 35°C)
- Rated lifetime (L70): 50,000hrs
- 5 year limited warranty**/ 10 year available
(see EXTENDED WARRANTIES table for information)



032624



SPECIFICATIONS

Product	Model	Equiv.	Input Voltage	Wattage	Lumens	CCT	CRI	Efficacy (LPW)	Power Factor	THD	Beam Angle	Base Rotatable Angle	Installation Orientation	Fixture Rating
36631	3.5PLS/835/BYP/2G7/R	7-9W	120-277V	3.5	350	3500K	82	100	0.9	<20%	120°	180°	Horizontal	Enclosed
36637	5.5PLS/835/BYP/2GX7/R	13W	120-277V	3.5	600	3500K	82	109	0.9	<20%	110°	180°	Horizontal	Enclosed
36627	3.5PLS/827/HYB/G23/R	7-9W	120-277V	3.5	325	2700K	82	93	0.9	<20%	120°	170°	Horizontal	Enclosed
36628	3.5PLS/830/HYB/G23/R	7-9W	120-277V	3.5	340	3000K	82	97	0.9	<20%	120°	170°	Horizontal	Enclosed
36629	3.5PLS/835/HYB/G23/R	7-9W	120-277V	3.5	350	3500K	82	100	0.9	<20%	120°	170°	Horizontal	Enclosed
36630	3.5PLS/840/HYB/G23/R	7-9W	120-277V	3.5	370	4000K	82	106	0.9	<20%	120°	170°	Horizontal	Enclosed
36632	5.5PLS/827/HYB/GX23/R	13W	120-277V	5.5	520	2700K	82	95	0.9	<20%	110°	170°	Horizontal	Enclosed
36633	5.5PLS/830/HYB/GX23/R	13W	120-277V	5.5	550	3000K	82	100	0.9	<20%	110°	170°	Horizontal	Enclosed
36634	5.5PLS/835/HYB/GX23/R	13W	120-277V	5.5	600	3500K	82	109	0.9	<20%	110°	170°	Horizontal	Enclosed
36635	5.5PLS/840/HYB/GX23/R	13W	120-277V	5.5	620	4000K	82	113	0.9	<20%	110°	170°	Horizontal	Enclosed
36645	5.5PLSH/830/HYB/GX23/R	13W	120-277V	5.5	580	3000K	82	105	0.9	<20%	110°	310°	Horizontal	Non-Enclosed
36646	5.5PLSH/835/HYB/GX23/R	13W	120-277V	5.5	600	3500K	82	109	0.9	<20%	110°	310°	Horizontal	Non-Enclosed
36647	5.5PLSH/840/HYB/GX23/R	13W	120-277V	5.5	620	4000K	82	113	0.9	<20%	110°	310°	Horizontal	Non-Enclosed
98403	5.5PLSV/827/HYB/GX23	13W	120-277V	5.5	570	2700K	82	104	0.9	<20%	120°	N.A.	Vertical	Non-Enclosed
98404	5.5PLSV/830/HYB/GX23	13W	120-277V	5.5	600	3000K	82	109	0.9	<20%	120°	N.A.	Vertical	Non-Enclosed
98405	5.5PLSV/835/HYB/GX23	13W	120-277V	5.5	600	3500K	82	109	0.9	<20%	120°	N.A.	Vertical	Non-Enclosed
98406	5.5PLSV/840/HYB/GX23	13W	120-277V	5.5	620	4000K	82	113	0.9	<20%	120°	N.A.	Vertical	Non-Enclosed

* Ballast Dependent. Please refer to www.greencreative.com for full ballast compatibility list.

** Please visit www.greencreative.com for Limited Warranty terms.



BYPASS AND HYBRID BYPASS PLS

DIMENSION & WEIGHT

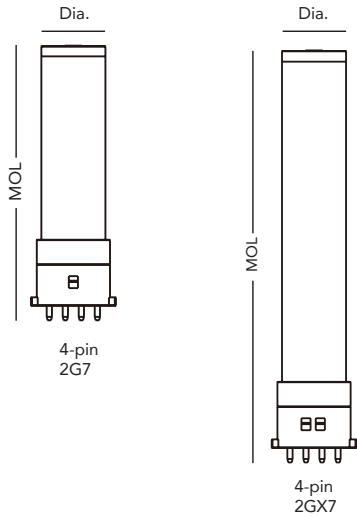

Model	3.5PLS/xxx/BYP/2G7/R	5.5PLS/xxx/BYP/2GX7/R
Compatible base	2G7 (4-pin)	2GX7 (4-pin)
MOL	4-3/4"	6-9/16"
Dia	1-7/16"	1-7/16"
Weight	0.06 lb	0.06lb

Where xxx means 824-965 which indicates CRI and color temperature

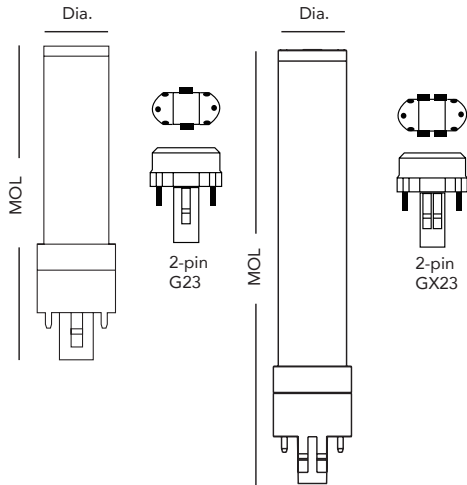

Model	3.5PLS/xxx/HYB/G23/R	5.5PLS/xxx/HYB/GX23/R
Compatible base	G23 (2-pin)	GX23 (2-pin)
MOL	5-5/16"	7"
Dia	1-1/4"	1-1/4"
Weight	0.08 lb	0.08 lb

Where xxx means 824-965 which indicates CRI and color temperature

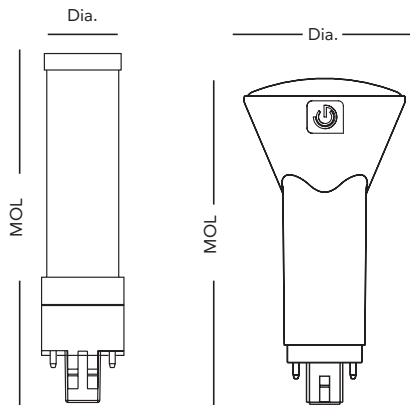

Model	5.5PLSH/xxx/HYB/GX23/R	5.5PLSV/xxx/HYB/GX23
Compatible base	GX23 (2-pin)	GX23 (2-pin)
MOL	5-1/2"	5-1/4"
Dia	1-3/8"	2-9/16"
Weight	0.15 lb	0.16lb

Where xxx means 824-965 which indicates CRI and color temperature



BYPASS AND HYBRID BYPASS PLS

HYBRID Installation - DIRECT (Magnetic Ballasts) or BYPASS

When used with a magnetic ballast, the lamp can function as a plug & play lamp and operate with the existing ballast.

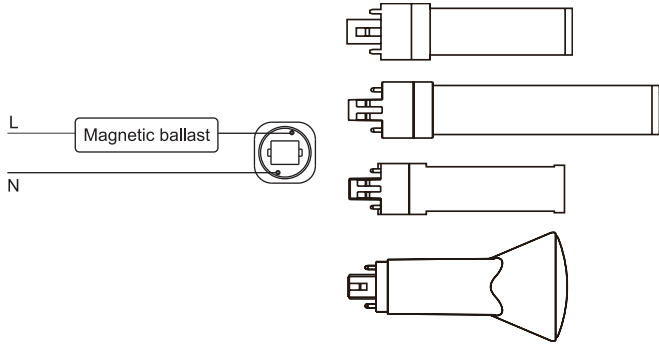

If the ballast is not compatible, it can be bypassed and the lamp can run directly off line voltage.

OR

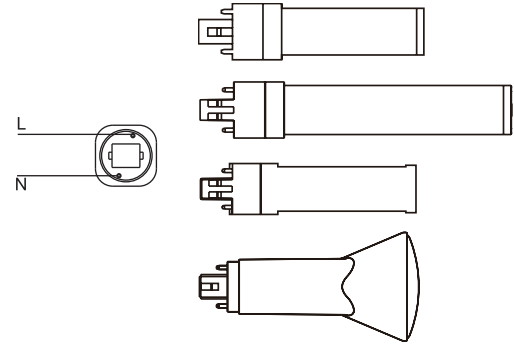

BYPASS Installation

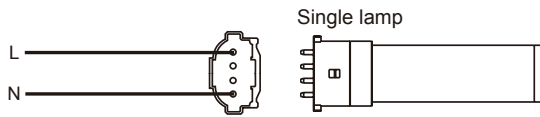

OR

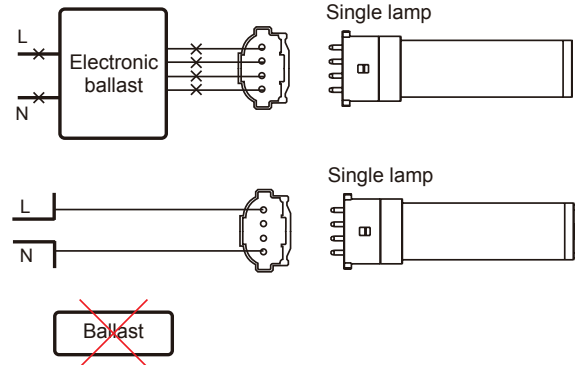

ACCESSORY ORDERING INFORMATION

Product	Model	Description	Pictures	Dimensions	Compatible Skus
37934	8EMINVERTER	California Title 20 Compliant 8W Emergency LED Inverter (Field Installation)			3.5PLS/8xx/BYP/2G7/R (Must connect 2 lamps) 3.5PLS/8xx/HYB/G23/R (Must connect 2 lamps) 5.5PLS/8xx/BYP/2GX7/R 5.5PLS/8xx/HYB/GX23/R 5.5PLSH/8xx/HYB/GX23/R 5.5PLSV/8xx/HYB/GX23

EXTENDED WARRANTIES***

Model	Description****
3.5PLS/BYP/10YEARWARRANTY	10 Year warranty for 3.5PLS/8xx/BYP/2G7/yy
5.5PLS/BYP/10YEARWARRANTY	10 Year warranty for 5.5PLS/8xx/BYP/2GX7/yy
3.5PLS/HYB/10YEARWARRANTY	10 Year warranty for 3.5PLS/8xx/HYB/G23/yy
5.5PLS/HYB/10YEARWARRANTY	10 Year warranty for 5.5PLS/8xx/HYB/GX23/yy
5.5PLSH/HYB/10YEARWARRANTY	10 Year warranty for 5.5PLSH/8xx/HYB/GX23/yy
5.5PLSV/HYB/10YEARWARRANTY	10 Year warranty for 5.5PLSV/8xx/HYB/GX23/yy

*** Warranty based on a maximum of 4,368 annual operating hours (per year for ten years) and exposure to a maximum fixture operating temperature of 80°F / 27°C

**** xx - Refers to the CCT yy - Refers to model generations within the same nominal performance. Typically blank, 'R', or 'RC'



BYPASS AND HYBRID BYPASS PLS

ORDERING INFORMATION

Model	Master Carton			Shipping Carton		
	Case Qty	Case Dimensions (LxWxH)	Case Weight	Case Qty	Case Dimensions (LxWxH)	Case Weight
3.5PLS/xxx/BYP/2G7/R	6PCS	5-5/16" x 3-5/8" x 3-3/16"	0.55lb	24PCS	11-1/8" x 7-9/16" x 3-9/16"	2.75lb
3.5PLS/xxx/HYB/G23/R	6PCS	5-5/16" x 3-5/8" x 3-3/16"	0.55lb	24PCS	11-1/8" x 7-9/16" x 3-9/16"	2.75lb
5.5PLS/xxx/BYP/2GX7/R	6PCS	7-7/8" x 3-1/8" x 3-1/8"	0.6lb	24PCS	16-1/4" x 6-3/4" x 3-1/2"	3.3lb
5.5PLS/xxx/HYB/GX23/R	6PCS	7-7/8" x 3-1/8" x 3-1/8"	0.6lb	24PCS	16-1/4" x 6-3/4" x 3-1/2"	3.3lb
5.5PLSH/xxx/HYB/GX23/R	6PCS	5-15/16" x 4-3/4" x 4-3/16"	1lb	24PCS	12-1/2" x 10-1/16" x 4-1/2"	5lb
5.5PLSV/xxx/HYB/GX23	6PCS	5-11/16" x 8-11/16" x 6-11/16"	1.4lb	24PCS	23-1/16" x 9-1/16" x 7-1/16"	7lb

Where xxx means 824-965 which indicates CRI and color temperature

Note: All rights reserved. All sizes and specifications are subject to change at any time without notice.