

CB22-LKFS

Lumen and Kelvin Field Selectable Center Basket



Project:	
Type:	
Catalog #:	

STANDARD



FEATURES

- Field selectable 3500k (warm/neutral white), 4000k (neutral white) & 5000k (cool white) color temperatures.*
- Long-life LEDs provide at least 196,000 hours of operation with at least 70% of initial lumen output (L_{70}).**
- Provides a range of 3,000 to 4,300 nominal lumens.*
- Uniform illumination with no visible LED pixilation.
- Universal 120-277 AC voltage (50-60Hz) is standard.
- 0-10vdc, continuous dimming capability is standard.
- Power factor > 0.90.
- Total harmonic distortion < 20%.
- Color rendering index (R_a) > 80.
- Steel housing and PMMA lens.
- Easy installation in new construction or retrofit. Fits in standard 2' x 2' grid ceilings.
- Built-in earthquake clips provide secure installation in grid ceilings.
- Standard mounting options include recessed mounting in grid ceilings, or suspended mounting using earthquake clips. For other mounting options, see Mounting Means (page 4).

* Contact factory for other color temperatures and lumen packages.
 ** L70 hours are IES TM-21-11 calculated hours.

WARRANTY & LISTINGS

- cULus listed for damp locations and insulated ceilings in ambient temperatures from -25°C to 50°C (-13°F to 122°F).
- UL listed for maximum of 4, 12 AWG through branch circuit conductor.
- Inherently protected.
- Type IC rated for insulated ceilings.
- DLC approved.
- Low risk of flicker (per IEEE1789-2015) at 100% light output level.
- Complies with FCC Part 15, class A.
- Complies with IEEE C.62.41-2002, input transient surge protection (2.5kV).
- 5-year warranty of all electronics and housing.

DIMENSIONS

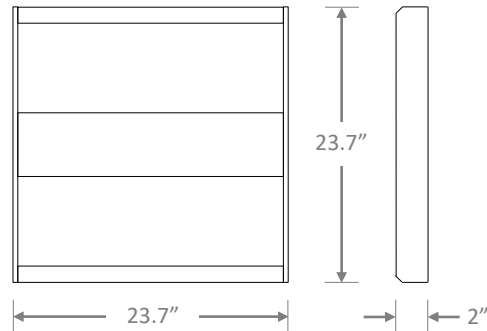

Weight: 7 lbs.

ORDERING INFORMATION

Example: CB22-4L-LKFS-EM13

Series	Nominal Lumen Output	Select	Externally Installed Emergency Drivers ¹		Accessories	
CB22	4L 4,000 nominal lumens	LKFS	EM5	755 lumens	DWS-010-T	0-10v dimmer, toggle switch
			EM10	1,617 lumens	DWS-010-D	0-10v dimmer, decora switch
			EM13	1,940 lumens	IP710-DLZ	0-10v dimmer, button switch
			Blank	No emergency driver		

¹ See emergency driver compatibility list (page 2).

COMPATIBLE EMERGENCY DRIVERS*

Emergency Driver Part Number	EM5		EM10		EM13	
	Watts	EM Lumens	Watts	EM Lumens	Watts	EM Lumens
CB22-4L-LKFS	5.0	755	10.7	1617	13.7	1940

* Suitable for ambient temperatures above 10°C (50°F).

ACCESSORIES (Order Separately)

Remote Mount Emergency Drivers*

- BLEM-CP-5C = Emergency driver - EM5
- BLEM-CP-10C = Emergency driver - EM10
- BLEM-CP-13C = Emergency driver - EM13

* Suitable for ambient temperatures above 10°C (50°F).

COMPATIBLE DIMMERS & CONTROLS

Manufacturer	Model Number	Dimming Range	Load Switching Capacity
Best Lighting	DWS-010V-T	10%-100%	600W
Best Lighting	DWS-010V-D	10%-100%	600W
Leviton	IP710-LFZ	10%-100%	1200W
Lutron	DVSTV	10%-100%	450W

ELECTRICAL DATA

Series	Measurements	Low Lumens			Mid Lumens			High Lumens		
		3500K	4000K	5000K	3500K	4000K	5000K	3500K	4000K	5000K
CB22-4L-LKFS	Lumens	3073	3176	3120	3640	3772	3649	4220	4370	4196
	Watts	22	22	22	27	27	27	32	31	32
	Efficacy	137	144	139	134	142	134	131	140	131
	Input Current (A)	120V = 0.18A	120V = 0.18A	120V = 0.18A	120V = 0.23A	120V = 0.23A	120V = 0.23A	120V = 0.27A	120V = 0.26A	120V = 0.27A
240V = 0.09A		240V = 0.09A	240V = 0.09A	240V = 0.11A	240V = 0.11A	240V = 0.11A	240V = 0.13A	240V = 0.13A	240V = 0.13A	
277V = 0.08A		277V = 0.08A	277V = 0.08A	277V = 0.10A	277V = 0.10A	277V = 0.10A	277V = 0.12A	277V = 0.11A	277V = 0.12A	

PHOTOMETRIC DATA

CB22-4L-LKFS

Luminaire Data

Description	Center Basket 2X2 4L 5K - LKFS
Total Lumens	4,205
Input Wattage	32
Efficacy (lm/W)	131
Spacing Criterion (0-180°)	1.24
Spacing Criterion (90-270°)	1.28

Zonal Lumen Summary

Zone	Lumens	%Fixt
0-20°	521	12.4%
0-30°	1,104	26.3%
0-40°	1,807	43.0%
20-50°	2,017	48.0%
40-70°	1,936	46.0%
0-60°	3,206	76.2%
0-80°	4,102	97.5%
0-90°	4,202	99.9%
90-180°	3	0.1%
0-180°	4,205	100.0%

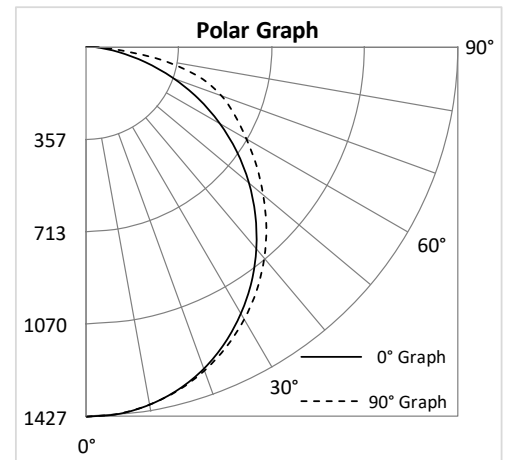

MOUNTING MEANS – ORDER SEPARATELY

- Optional surface mounting kits (SMKT-22) mounts below the ceiling.
- Optional flange mounting kits provide for recessed installation on plaster or other hard ceilings. Attach Flange Mount Kit (FLANGEKIT22-ET) to ceiling joists or other stationary structures, and the panel is mounted flush to the ceiling.
- Optional cable mounting kits provide additional security, as well as suspended mounting. Attach one end of the Cable Mount Kit (PNL-CM) to luminaire earthquake clips using spring clips, and attach the other end to stationary structures using the adjustable, locking ceiling attachment (see picture below right).

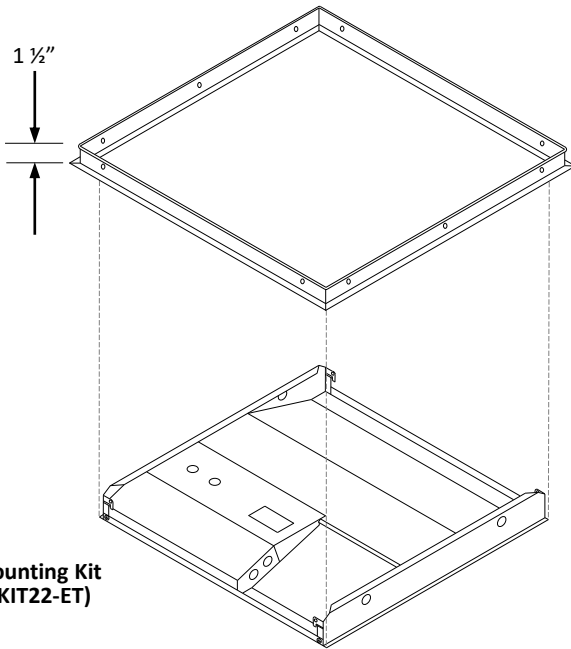
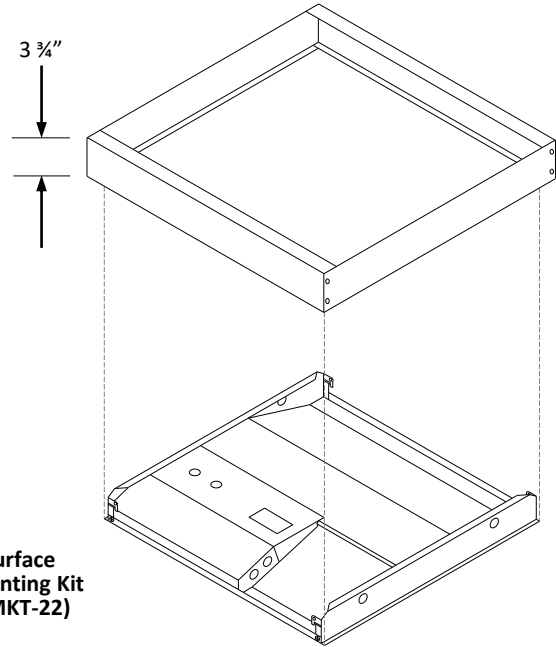

Cable Mounting Kit (PNL-CM)

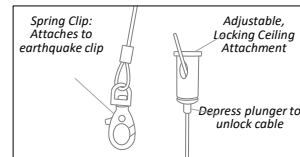

Cable Mount Kit:

- Spring Clip
- Adjustable, locking ceiling attachment